

MRL Home elevator

Wire rope traction

Control cabinet size

NOTE

Technical Requirement

Hoistway Structure

Concrete  Brick & Concrete  Other

Schematic diagram of hook

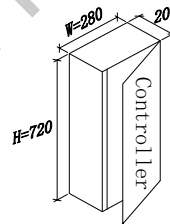
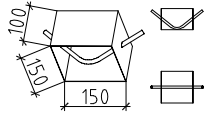

HW	HOISTWAY WIDTH	CW	CAR INSIDE WIDTH
HD	HOISTWAY DEPTH	CD	CAR INSIDE DEPTH
OP	DOOR OPENING WIDTH	CH	CAR HEIGHT
ROP	WALL OPENING WIDTH	OH	OVERHEAD HEIGHT
OPH	DOOR OPENING HEIGHT		
CAR DBG	DISTANCE BETWEEN CAR GUIDE RAILS		
CWT DBG	DISTANCE BETWEEN COUNTERWEIGHT GUIDE RAILS		

type		TJJ 400 / 0.4	
F/P/D	/ /	Door type	Four Panels Centre Opening
load	400 kg	Speed	0.4 m/s
Machine		Roping	2:1
T/sheave	φ 200	D/sheave	φ
car sheave	φ 200	CW sheave	φ 320
Shaft	HW 1350	mm x HD 1500	mm
Cabin	CW 950	mm x CD 950	mm
Door	OP 800	mm x OPH 2000	mm
Speed	0.4		(m/s)
Power	1.9		(KW)
OH	≥3300		(mm)
Pit	≥300		(mm)

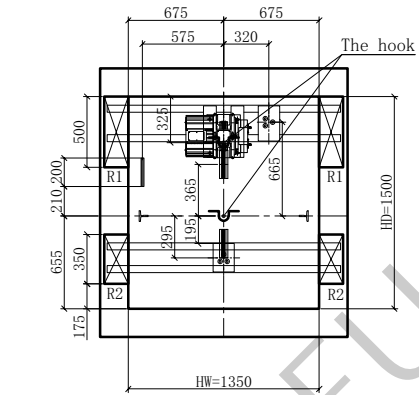

Overhead plan

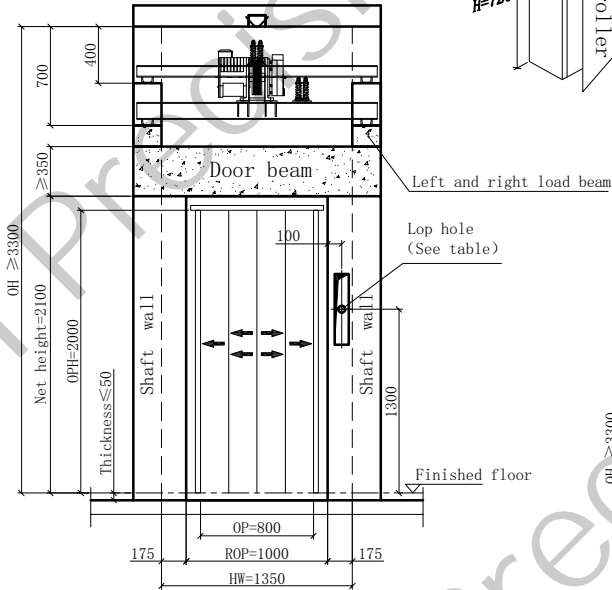

E direction Doorway schematic Facing Hoistway

	base station	remaining stations
Bottom box Lop	100 Wx500 H	100 Wx400 H
No bottom box	φ50 hole	

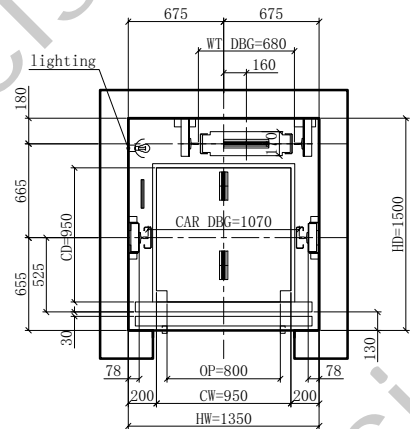

Hoistway plan

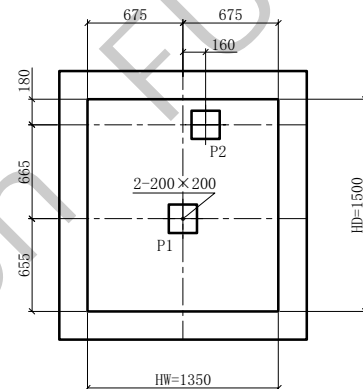

Pit plan

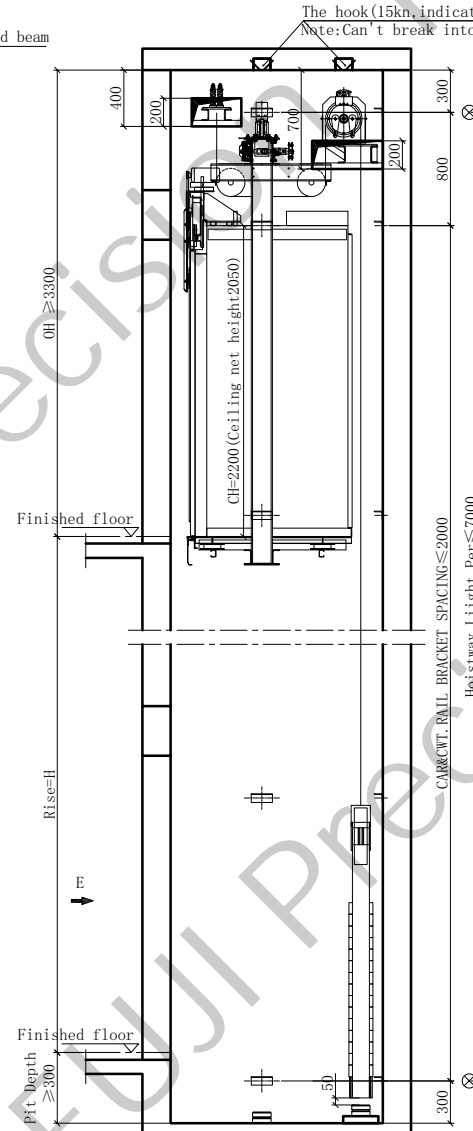

current  
380V 3phase 5wire, 50Hz, Fluctuation ±7%

Support Force (N)							
R1	R2	R3	R4	P1	P2	P3	P4
28800	17200			45000	34000		

The work that the owner and the construction party should complete

1. The construction and waterproofing of pit about the shaft and machine room;
2. The dynamic power from the receiving box, piping of lighting earth line project and including the main switch;
3. Reserved hole about each exists and machine room floor;
4. The filling and whitewash project after finishing the installation about elevators door frame;
5. Machine room door, ventilation, lighting and the cinder and concrete on the floor after finishing the construction;
6. Piping and wiring about the emergency call from machine room to management room;

Others:  
In accordance with the providing of the building ordinance, it is not allowed to arrange water pipe, electricity pipe, wind pipe in the shaft that are in perspective with the elevator.

OH	≥ 3300
Rise	H
5F	
4F	
3F	
2F	
1F	
-1F	
-2F	
-3F	
Pit	≥ 300

Drawing		Approver	
Drawing No.		FT-J 400 -05-	
Manufacturing no.			
Project name			

FUJI PRECISION